

The PLUTO baseband interface circuit is designed for use in dual mode CDMA/AMPS digital cellular telephones. In the telephone, Pluto provides the interface between the radio (RF & IF) components and the baseband digital signal processor. Pluto is part of a complete chipset solution for CDMA phones entitled the Planet chipset.

The receive (RX) section converts the analog in-phase and quadrature (I & Q) signals into equivalent digital signals whilst the transmit (TX) circuits perform the complementary function of translating digital baseband information into the analog equivalent signals required for the modulator in the radio circuits. VHF PLLs are also included for second RXLO and TXIF generation.

PLUTO also contains a 4 channel general purpose ADC which is included for such purposes as environmental and signal strength monitoring.

#### FEATURES

- Dual mode AMPS/CDMA compatible
- Low Power/Low Voltage operation
- Standard baseband I and Q interface
- 4 Input Auxiliary ADC
- Synthesisers

#### APPLICATIONS

- Dual Mode CDMA/AMPS digital cellular telephones

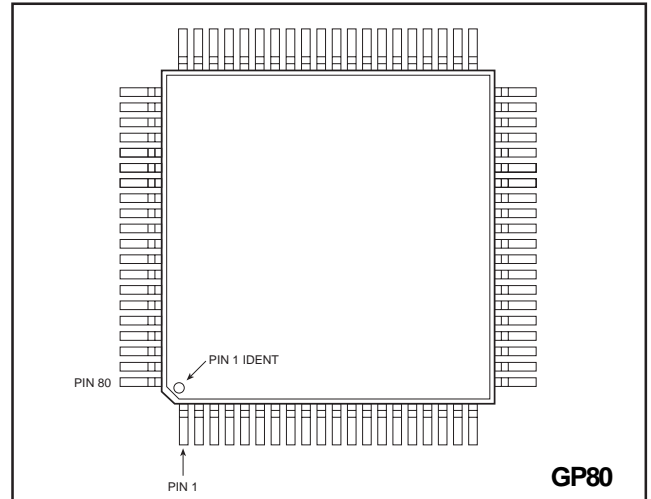

Figure 1 Pin connections - top view

#### ABSOLUTE MAXIMUM RATINGS

Supply voltage	-0.3 to 3.9V
Voltage applied to any other pin	-0.3 to V <sub>cc</sub> +0.3V
Operating junction temperature	150°C
Storage temperature	-55°C to 150°C
ESD (human body model)	2kV

#### ORDERING INFORMATION

PLUTO/KG/GP1R

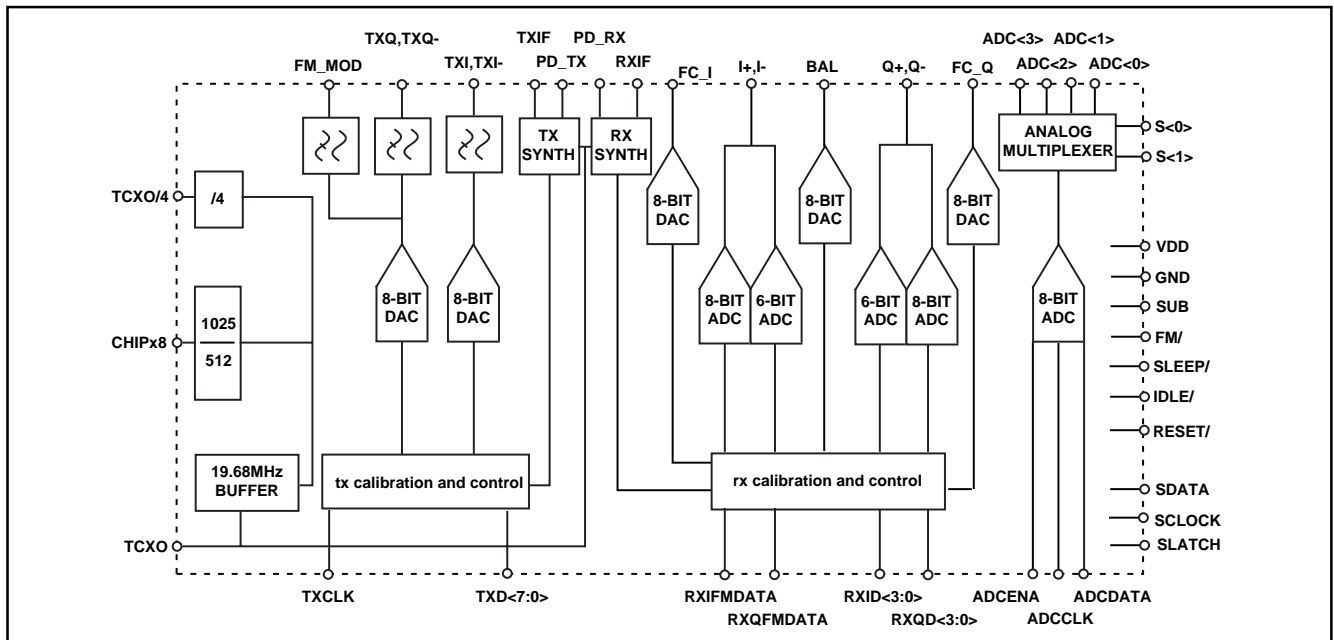

Figure 2 Block diagram

# PLUTO

## PIN DESCRIPTION

No	Pin Name	Type	A/D	Description
1	VDD	Power		Power Supply
2	RSET	Input	Analog	Bias current setting resistor - 40kΩ to ground
3	GND	Ground		Ground
4	TX_IF	Input	Analog	TX VCO output
5	IDLEB	Digital		Idle mode control signal - active low - pulled low if left unconnected
6	PD_TX	Output		TX synthesiser charge pump output
7	FMB	Input	Digital	FM mode control signal - active low - pulled low if left unconnected
8	PD_RX	Output	Analog	RX synthesiser charge pump output
9	SLEEPB	Input	Digital	Sleep mode control signal - active low - pulled low if left unconnected
10	RX_IF	Input	Analog	RX VCO output
11	TX_LOCK	Output	Digital	TX synthesiser lock detect open drain output - pulled high by ext. resistor
12	RX_LOCK	Output	Digital	RX synthesiser lock detect open drain output - pulled high by ext. resistor
13	TCXO/4	Output	Digital	TCXO divided by 4 output
14	TXD<0>	Input	Digital	Transmit data bit 0 (lsb)
15	TXD<1>	Input	Digital	Transmit data bit 1
16	TXD<2>	Input	Digital	Transmit data bit 2
17	TXD<3>	Input	Digital	Transmit data bit 3
18	TXD<4>	Input	Digital	Transmit data bit 4
19	TXD<5>	Input	Digital	Transmit data bit 5
20	TXD<6>	Input	Digital	Transmit data bit 6
21	TXD<7>	Input	Digital	Transmit data bit 7 (MSB)
22	TXCLK	Input	Digital	Complimentary Transmit Clock (+ve)
23	TXCLKB	Input	Digital	Complementary Transmit Clock (-ve)
24	CHIPx8	Input	Digital	9.8304MHz synthesiser output
25	VDD	Power		Power Supply
26	TCXO	Input	Analog	TCXO 19.68MHz a.c. coupled sinewave input
27	GND	Ground		Ground
28	SUB	Ground		Substrate-Ground
29	RESET	Input	Digital	Chip master reset - pulled high if not connected
30	SDATA	Input	Digital	Serial Interface Data Input
31	SCLK	Input	Digital	Serial Interface Clock Input
32	SLATCH	Input	Digital	Serial Interface Latch Input
33	S<0>	Input	Digital	Aux ADC mux channel select LSB
34	n/c			
35	RXID<0>	Output	Digital	I-Channel RX CDMA output LSB - low when inactive
36	RXID<1>	Output	Digital	I-Channel RX CDMA output bit 1 - low when inactive
37	RXID<2>	Output	Digital	I-Channel RX CDMA output bit 2 - low when inactive
38	RXID<3>	Output	Digital	I-Channel RX CDMA output bit 3 - low when inactive
39	S<1>	Input	Digital	Aux ADC mux channel select MSB
40	n/c			
41	RXQD<0>	Output	Digital	Q_Channel RX CDMA output LSB - low when inactive
42	RXQD<1>	Output	Digital	Q_Channel RX CDMA output bit 1 - low when inactive
43	RXQD<2>	Output	Digital	Q_Channel RX CDMA output bit 2 - low when inactive
44	RXQD<3>	Output	Digital	Q_Channel RX CDMA output bit 3 - low when inactive
45	GND	Ground		Ground
46	VDD	Power		Power Supply
47	RXFMSTB	input	Digital	Receive data FM strobe - pulled low if not connected
48	FMCLK	Input	Digital	Receive data FM clock - pulled low if not connected
49	RXQFMDATA	Output	Digital	Q-Channel RX FM data serial output - low when inactive
50	RXIFMDATA	Output	Digital	I-Channel RX FM data serial output -low when inactive
51	ADCLK	Output	Digital	Auxiliary ADC serial data clock. Low when inactive
52	ADCDATA	Output	Digital	Auxiliary ADC serial data output. Low when inactive
53	ADCENA	Input	Digital	Auxiliary ADC enable - pull down if not used
54	SUB	Ground		Substrate - Ground

## PIN DESCRIPTION (continued)

No	Pin Name	Type	A/D	Description
55	RXQP	Input	Analog	Receive Q Channel Input (+ve)
56	RXQM	Input	Analog	Receive Q Channel Input (-ve)
57	SUB	Ground		Substrate - Ground
58	RXIP	Input	Analog	Receive Q channel input (+ve)
59	RXIM	Input	Analog	Receive Q channel Input (-ve)
60	VDD	Power		Power Supply
61	GND	Ground		Ground
62	VREF<0>	Input/Output	Analog	CDMA Receive Circuit Voltage Reference De-Coupling
63	AD<0>	Input	Analog	AUX ADC Input
64	AD<1>	Input	Analog	AUX ADC Input
65	AD<2>	Input	Analog	AUX ADC Input
66	AD<3>	Input	Analog	AUX ADC Input
67	Vtest	Output	Digital	RX Filter tuning tone output - pulled low when inactive
68	EnTest	Output	Digital	RX Filter tuning mode control output - pulled low when inactive
69	FC_Q	Output	Analog	RX Filter Q channel FC control
70	FC_I	Output	Analog	RX Filter channel FC control
71	BAL	Output	Analog	RX Filter Gain Balance Control
72	VDD	Power		Power Supply
73	GND	Ground		Ground
74	TXIP	Output	Analog	Transmit Circuit channel Complementary Output (+ve)
75	TXIM	Output	Analog	Transmit Circuit I channel Complementary Output (-ve)
76	SUB	Ground		Substrate - Ground
77	TXQP	Output	Analog	Transmit Circuit Q channel Complementary Output (+ve)
78	TXQM	Output	Analog	Transmit Circuit Q channel Complementary Output (-ve)
79	FMTX	Output	Analog	Transmit Circuit FM output
80	VREF<1>	Input/Output	Analog	Transmit Circuit Voltage Reference De-coupling

**FUNCTIONAL DESCRIPTION**

## Baseband TX interface circuit

The Pluto baseband transmit circuit acts as an interface between the baseband signal processor and the RF/IF sections in a CDMA/AMPS compatible mobile telephone.

The TX circuit has two modes of operation :

CDMA mode, transmit data that has previously been encoded by the baseband digital signal processor is converted to equivalent analog signals by matched digital-to-analog converters, these signals are then filtered to remove the image of the sample clock that would otherwise be present at the output before being output to the I and Q modulator as differential signals.

FM mode, transmit data is treated in much the same way as in CDMA mode except that only one DAC is used and (because of the much lower bandwidth of AMPS signals) a different reconstruction filter is used before the analog fm signal is output to the mixer as a single ended signal.

**CDMA Transmit Signal Path****CDMA TX DACs**

In CDMA mode two matched 8-bit DACs are used to generate the in-phase and quadrature signals, the input data for the DACs is obtained by multiplexing over an 8-bit parallel input port (TXD<7:0>). The transmit data rate is twice as fast as the differential transmit clock (TXCLK). Incoming data that is valid during the rising edge of the transmit clock is loaded into in-Phase DAC & incoming data that is valid on the falling edge of the transmit clock is loaded into the Quadrature DAC - I and Q values must be modified in the digital baseband chip to account for the half-cycle delay between them.

**CDMA Analog Reconstruction Filters**

The frequency spectrum at the output of the transmit DACs contains unwanted frequency components. Reconstruction filters are used to smooth the DAC output signals, providing continuous time output signals at the I and Q output pins thereby removing these undesirable signals.

The low pass filters used are 5th order Butterworth, continuous time filters with a nominal cut-off frequency of 1.2 MHz. These filters are designed to have a linear phase response in the pass band. On-chip reconstruction filters minimise the phase and amplitude mismatch between I and Q channels.

## PLUTO

### CDMA TX Section Analog Interface

The ITx and QTx outputs can be d.c. or a.c. coupled to the external circuits and will differentially drive a minimum resistive load of 5 k $\Omega$  and a maximum capacitive load of 20 pF.

When the CDMA transmit path is in power-down mode the positive outputs goes high and the negative output goes low.

### FM Transmit Signal Path

#### FM TX DAC

In FM mode, the Q-Channel DAC is used to generate an analog FM modulation signal from the data transmitted from the digital baseband processor. In this mode, all other CDMA TX circuits are powered down.

### FM Mode Analog Reconstruction Filters

The frequency spectrum at the output of the transmit DAC contains unwanted frequency components. A reconstruction filter is used to smooth the DAC output signals.

Low-pass filters are used with a cut-off frequency of approximately 13 kHz. These filters are 3rd order Butterworth filters.

### FM TX Section Analog Interface

The FMTX output can be d.c. or a.c. coupled to the radio circuits and will drive a minimum resistive load of 5 k $\Omega$  and a maximum capacitive load of 20 pF.

When the FM mode is in power-down the output is in high impedance state.

### CDMA Receive Signal Path

#### CDMA Receive ADC

In CDMA mode two high speed 4-bit ADCs are used to digitise the incoming signals before subsequent transmission to the baseband digital signal processor as two parallel 4 bit words (RXI<3:0> and RXQ<3:0>). The sample rate of 9.8304MHz is generated via an on chip synthesiser that requires no setting up or external components. On each falling edge of the synthesised clock (CHIPx8) a new digital sample is output on the digital bus.

### CDMA Receive Calibration Circuit

On entering into CDMA mode from power down or from FM mode the calibration circuits are activated. These circuits measure the differences between the receive path gain in the pass band and in the transition band of both I and Q filters. Via a successive approximation process they tune the receive filters cut-off frequency and amplitude matching using the 8 bit DACs provided for this purpose (I\_FC, Q\_FC and BAL). Once both filters (I and Q) have been calibrated in this way the DAC outputs will not change until the chip is powered down or the calibration circuit is re-activated in some other way.

### FM Receive Signal Path

In FM mode two low speed 8-bit ADCs are used to digitise the incoming signals before subsequent transmission to the baseband digital signal processor as two serial 8-bit words (FMRXI & FMRXQ). The sample rate is entirely determined by the digital baseband processor (up-to the maximum allowed) via the FMCLK input.

In FM mode the receive filters are assumed to track the filters used in CDMA mode i.e. there is no separate tuning mechanism.

## SYNTHESISERS

The Synthesiser block comprises the input buffers, main dividers, phase comparator, charge pump and lock detect circuit for a TX and RX synthesiser. The loop filter components and the VCOs are external to the device. A common reference divider chain is also included together with bias and control circuitry. All blocks apart from reference divider, bias and control logic are duplicated exactly for RX and TX synthesisers.

The receive intermediate frequency (RX\_IF) is programmable and the transmit intermediate frequency (TX\_IF) is fixed at 130.38MHz.

## AUX ADC

The auxiliary converter section contains a single 8-bit successive approximation analog to digital converter, with serial output. In order to maximise the flexibility of Pluto, a 4 way analog multiplexer is provided, which enables the converter to encode any one of four selectable channels. The converter is intended for such applications as power supply and temperature monitoring. When not in use, the converter is powered down, and its outputs are held low.

## TIMING INFORMATION

Parameter	Value			Units	Conditions
	Min	Typ	Max		
t1 TXCLOCK PERIOD (CDMA TX)		203.2		ns	CDMA TX Figure 3
t2 TXCLOCK HIGH TIME (CDMA TX)		101.6		ns	CDMA TX Figure 3
t3 TXCLOCK LOW TIME (CDMA TX)		101.6		ns	CDMA TX Figure 3
t4 TXCLOCK PHASE Delay (CDMA TX)			1.2	ns	CDMA TX Figure 3, FM TX Figure 4
t5 TXCLOCK RISE TIME (CDMA TX)			12	ns	CDMA TX Figure 3, FM TX Figure 4
t6 TXCLOCK FALL TIME (CDMA TX)			12	ns	CDMA TX Figure 3, FM TX Figure 4
t7 TXD-TXCLOCK SETUP TIME	20			ns	CDMA TX Figure 3, FM TX Figure 4
t8 TXCLOCK-TXD HOLD TIME	3			ns	CDMA TX Figure 3, FM TX Figure 4
t11 TXCLOCK PERIOD (FM TX)		2.78		μs	FM TX Figure 4
t12 TXCLOCK HIGH TIME (FM TX)		1.39		μs	FM TX Figure 4
t13 TXCLOCK LOW TIME (FM TX)		1.39		μs	FM TX Figure 4
t14 CHIPx8 PERIOD		101.6		ns	Figure 5
t15 CHIPx8 HIGH TIME		50.8		ns	Figure 5
t16 CHIPx8LOW TIME		50.8	152.4	ns	Figure 5
t17 CHIPx8 RISE TIME	3		12	ns	Figure 5
t18 CHIPx8 FALL TIME	3		12	ns	Figure 5
t19 RXD Hold Time After CHIPx8↓	10			ns	Figure 5
t20 RXD DELAY After CHIPx8↓			20	ns	Figure 5
t21 FMCLK PERIOD		2.78		μs	FM RX Figure 6
t22 FMCLK HIGH TIME		1.39		μs	FM RX Figure 6
t23 FMCLK LOW TIME		1.39		μs	FM RX Figure 6
t24 FMCLK RISE TIME			12	ns	FM RX Figure 6
t25 FMCLK FALL TIME			12	ns	FM RX Figure 6
t26 RXFMSTB HIGH TIME	1			μs	FM RX Figure 6
t27 RXFMSTB -FMCLK↓ SETUP TIME	50			ns	FM RX Figure 6
t28 FMCLK↓ – RXFMSTB HOLD TIME	50			ns	FM RX Figure 6
t29 FMCLK↓ – OUTPUT DATA DELAY			50	ns	FM RX Figure 6
t30 ADCENA HIGH _ CONVERSION			40	μs	General purpose ADC Figure 7
t31 ADCENA HIGH TIME	100			ns	General purpose ADC Figure 7
t32 ADCENA LOW TIME	100			ns	General purpose ADC Figure 7
t33 ADCCLK PERIOD		2.44		μs	General purpose ADC Figure 7
t34 ADCCLK HIGH TIME		0.81		μs	General purpose ADC Figure 7
t35 ADCCLK LOW TIME		1.62		μs	General purpose ADC Figure 7
t36 ADCCLK RISE TIME			12	ns	General purpose ADC Figure 7
t37 ADCCLK FALL TIME			12	ns	General purpose ADC Figure 7
t38 ADCDATA VALID BEFORE ADCCLK↑		1		μs	General purpose ADC Figure 7
t39 ADC DATA HOLD TIME	5			ns	General purpose ADC Figure 7
t40 SCLK-SDATA setup time	20			ns	Serial Interface Figure 8
t41 SCLK-SDATA hold time	20			ns	Serial Interface Figure 8
t42 SCLK pulse width	50			ns	Serial Interface Figure 8
t43 SLATCH-SCLK setup time	20			ns	Serial Interface Figure 8
t44 SLATCH pulse width	50			ns	Serial Interface Figure 8
t45 SCLK period	100			ns	Serial Interface Figure 8

# PLUTO

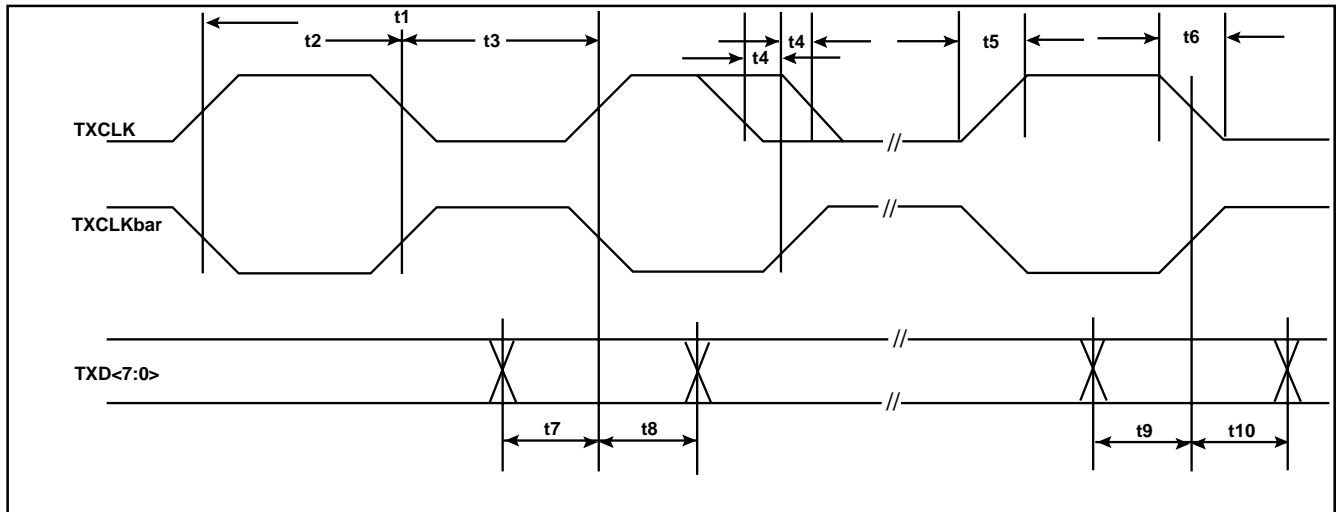

Figure 3 CDMA TX Mode

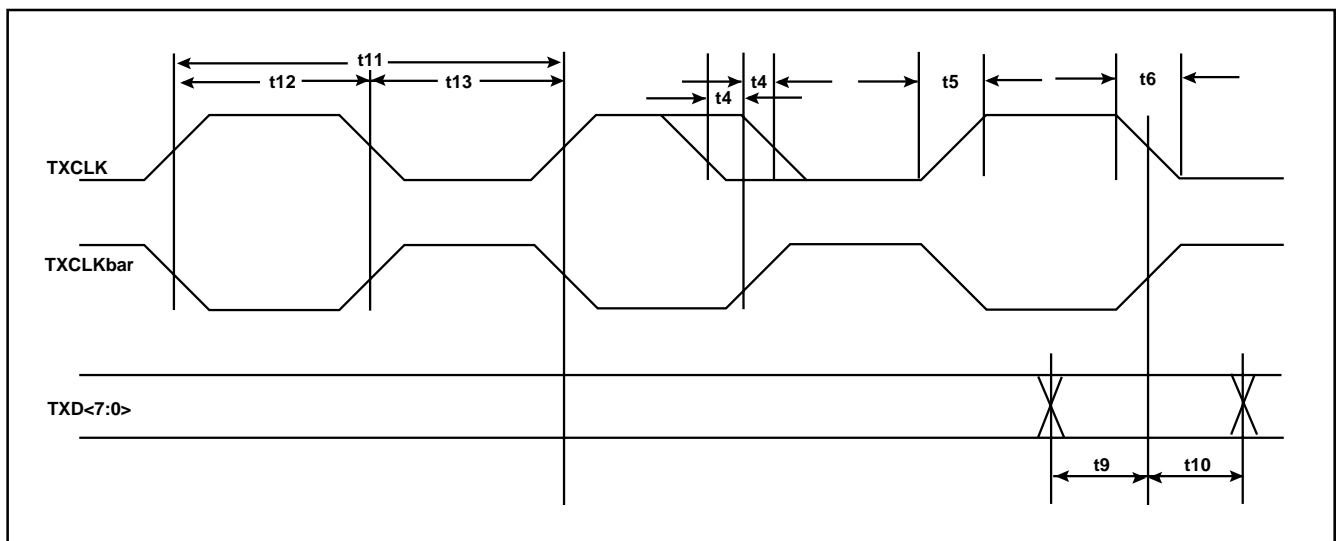

Figure 4. FM TX MODE

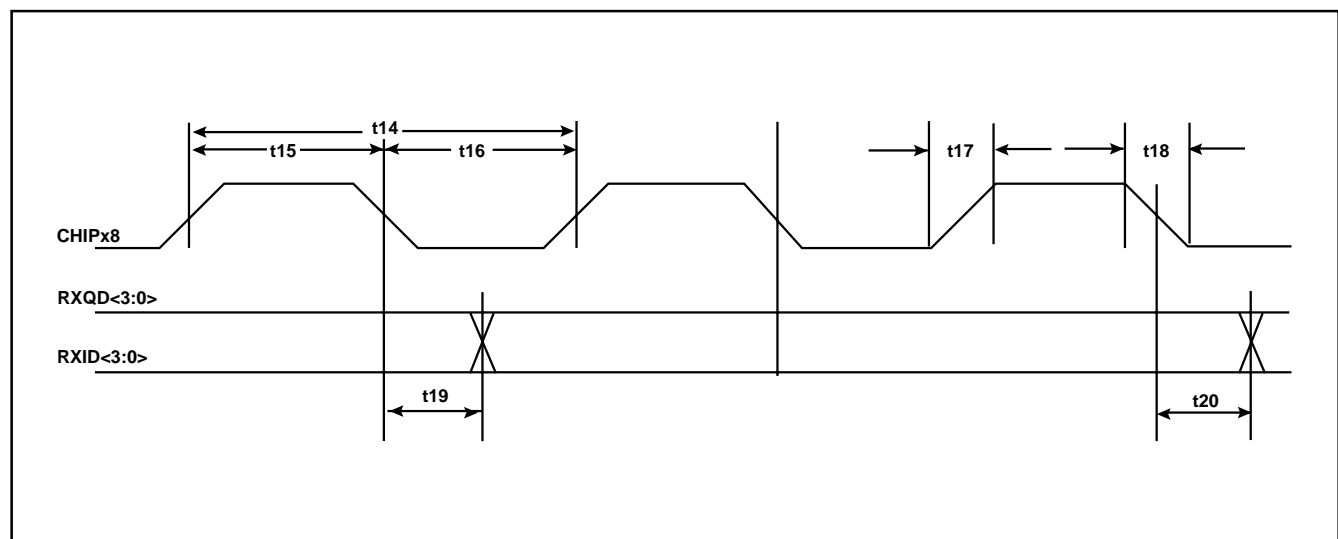

Figure 5. CDMA RX MODE

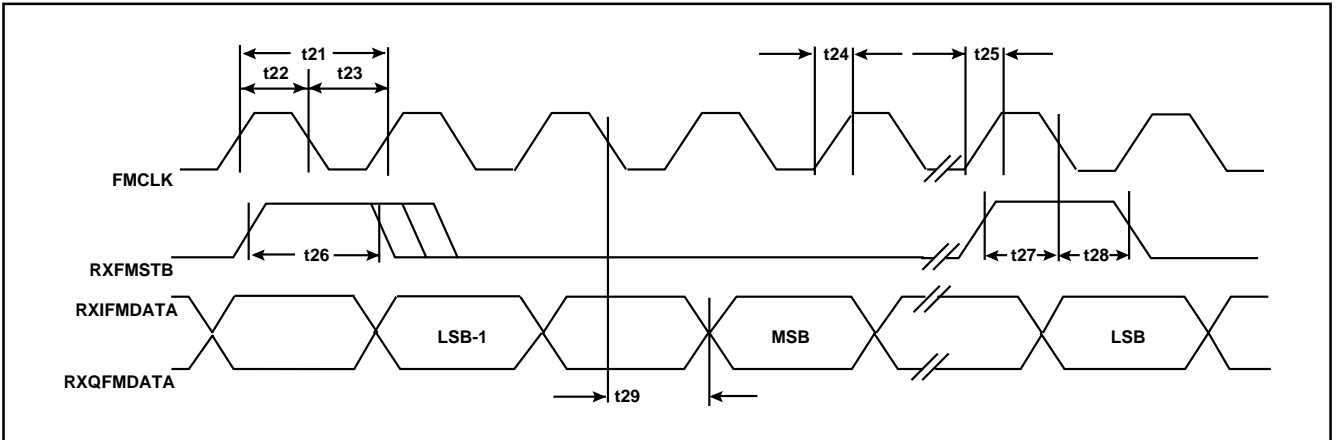

Figure 6. FM RX MODE

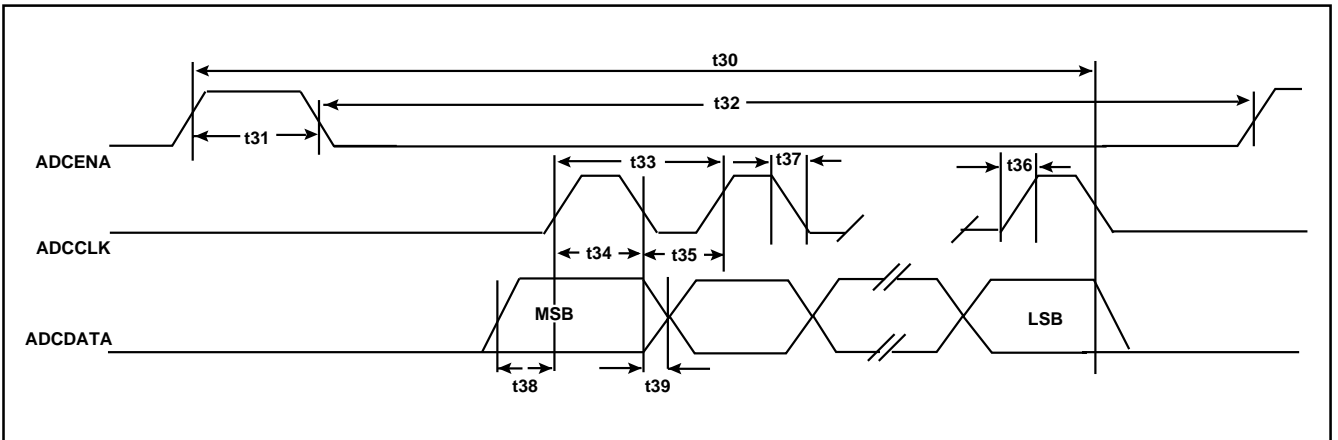

Figure 7. General purpose ADC

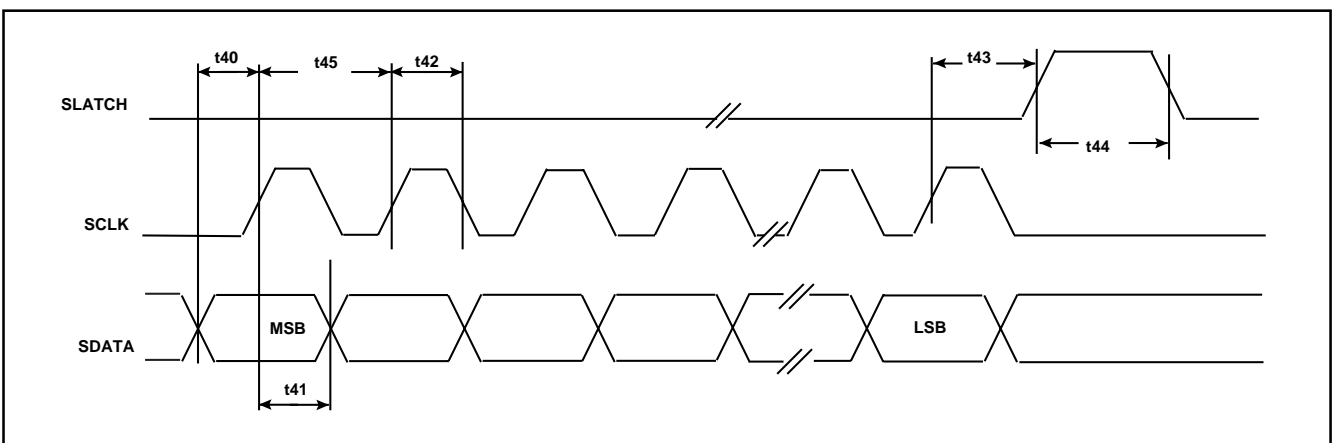

Figure 8. Serial interface

# PLUTO

## PROGRAMMING and CONTROL

The control modes for Pluto can be set via external pins or via a 3 wire serial interface. On initialising Pluto control is from external pins but can then be set for programming from the serial interface by setting the appropriate bit in a serial input word. The Rx second LO synthesiser is programmed via the serial interface: the Tx IF synthesiser is fixed and requires no programming.

### Mode Control - External

The control modes are set by the pins SLEEPB, FMB and IDLEB as shown in the table below:

SLEEPB (Pin 9)	FMB (Pin 7)	IDLEB (Pin 5)	Mode
0	X	X	Sleep Mode
1	0	0	FM Receive only
1	0	1	FM Receive and Transmit
1	1	0	CDMA Receive only
1	1	1	CDMA Receive and Transmit

### Aux ADC Selection - External

The auxiliary analog to digital converters can be selected via pins S0 and S1 as shown in the table below:

S1 (Pin 39)	S0 (Pin 33)	ADC selected
0	0	ADC<0>
0	0	ADC<1>
1	0	ADC<2>
1	1	ADC<3>

ADC selection can also be programmed to be via serial interface if required

### Serial Interface

The 3 wire serial interface (SDATA, SCLK and SLATCH) is programmed using 24 bit words as shown below. Timing details are shown in Figure 8.

MSB													LSB												
	23	22	21	20	19	18	17	16	15	14	13	12	11	10	9	8	7	6	5	4	3	2	1	0	
WORD1	0	0	0	0	0	X	X	RXC						RXDIV<13:0>										0	0
WORD2	SOP	FMB	IDB	SLB	0	0	0	0	0	0	AD1	AD0	TST	0	0	0	0	0	MXS	CTB	0	0	0	0	1

- X unused
- RXC RX Synth comparison frequency :0 = 30kHz, 1 = 5kHz
- RXDIV<13:0> RX Synth divider ratio
- SOP External/ Serial mode selection: 0 = Ext, 1 = Serial
- SLB, IDB, FMB Sleep, Idle and FM mode control bits (serial mode)
- TST Test Mode Control - This is for test purposes only and should be set to 0
- AD1, AD0 Aux ADC select bits (serial mode)
- MXS External / Serial Aux ADC select: 0 = Ext
- CTB Enable Rx Calibration: 0 = calibration mode

If SOP is high mode control is via serial bits FMB, IDB and SLB, instead of external pins FMB, IDLEB and SLEEPB.

If MXS is high then ADC selection is via AD1, AD0 instead of S<1>, S<0>



**INITIALISATION**

**Transmit**

On power-up or reset (RESETB) the Tx reconstruction filters are tuned to give the specified cut-off frequency. This calibration is internal and requires no external input. The calibration time is 1ms.

**Receive**

On power-up or reset (RESETB) an autocalibration algorithm is started which can be used to tune the programmable filters in Jupiter. (Jupiter is a programmable active filter designed for use in dual mode CDMA/AMPS system -further details of which can be found in the Jupiter Datasheet). The autocalibration is also initiated when Pluto is switched into CDMA mode via FMB control.

When Pluto enters calibration mode the En Test (pin 68) goes high. A test signal at 364kHz is then generated at the Vtest output (pin 67). This signal is input to Jupiter which provides a response which is digitised by the I and Q Rx ADCs. An output DAC - BAL - (Pin 71) then tunes the Q channel to match the I and Q channel amplitude via a successive approximation routine. The test signal is then switched to 728kHz which is above the required cut off of the filter. DAC outputs, FC\_I and FC\_Q are then adjusted to tune the I and Q filters to the correct amplitude with reference to the in band test signal. The filter cut off is tuned to 690kHz. Oversampling in the Rx ADC's ensures sufficient accuracy for the calibration. This calibration routine takes 26ms and after completion En Test goes low and the test signal Vtest is disabled. Only the CDMA filter is tuned, the matching within Jupiter ensures that the FM (AMPS) filter performance meets specification.

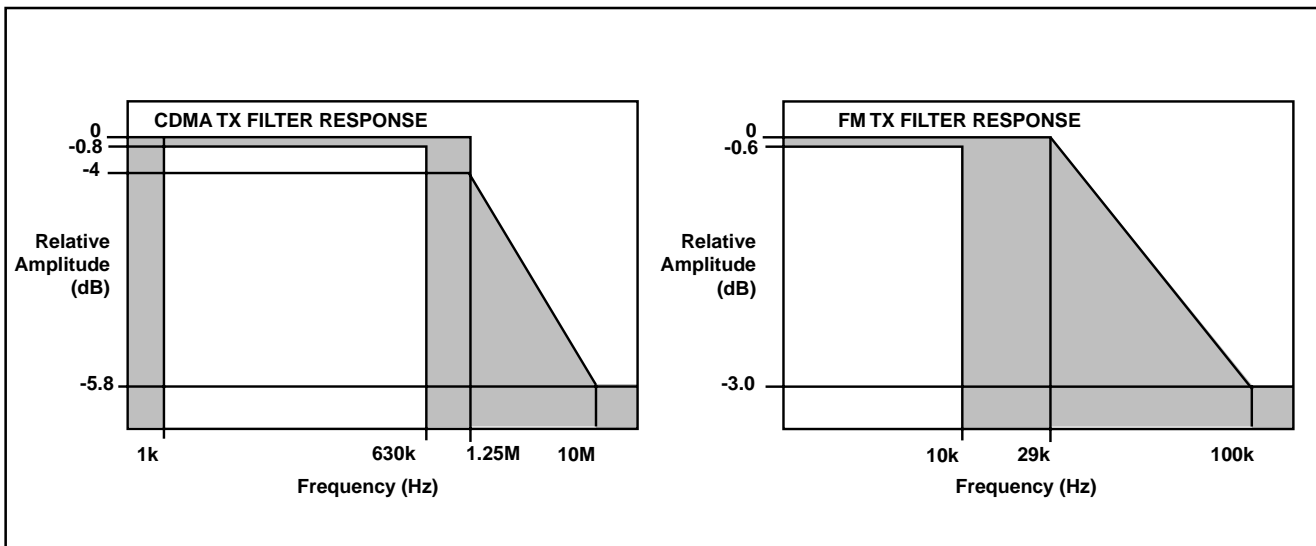

Figure 9 Baseband RX interface circuit

# PLUTO

## RECOMMENDED OPERATING CONDITIONS

Characteristic	Value			Units	Conditions	
	Min	Typ	Max			
Operating voltage range	2.7		3.6	V	AC coupled 19.68MHz sinusoidal signal	
Operating temperature range	-40		+85	°C		
Input high voltage, VIH	VDD-0.8			V		
Input low voltage, VIL			0.8	V		
Master clock amplitude	800			mV pk-pk		
Input current, I <sub>IH</sub>			0.1	µA		
Input capacitance, C <sub>IN</sub>			5	pF		
Output high voltage, VOH	VDD-0.4			V		I <sub>OOUT</sub> = 100µA
Output low voltage, VOL			0.4	V		I <sub>OOUT</sub> = 100µA
Tri-state leakage current			10	µA		

## ELECTRICAL CHARACTERISTICS

T<sub>AMB</sub> = -30°C to +70°C, V<sub>CC</sub> = +2.7 to +3.6V. These characteristics are guaranteed by either production test or design. They apply within the specified ambient temperature and supply voltage ranges unless otherwise stated.

Characteristic	Value			Units	Conditions	
	Min	Typ	Max			
<b>CDMA TX Interface</b>						
Resolution	8			Bits	V <sub>pp</sub> differential	
Integral non-linearity			0.5	LSB		
Differential non-linearity			0.5	LSB		
Full scale output Voltage	1.6	2.05	2.4	V		
Output common mode Voltage	1.1	1.2	1.3	V		
+Ve output Voltage in Power-down mode	Vdd-0.16	Vdd-0.1	Vdd-0.04	V		
-Ve output Voltage in Power-down mode	0.04	0.1	0.16	V		
I,Q gain mismatch			0.15	dB		
I,Q phase imbalance			1	degrees		
Differential offset			TBD	mV		
PSRR		50		dB	VDD to differential I & Q outputs, 100mV pk-pk at 100kHz	
Load resistance	5			kΩ	Butterwoth low pass	
Load capacitance			20	pF		
Filter type						
Filter order		5th				
Filter cut off						See Figure 9
Filter Pass Band ripple						See Figure 9
Filter stop band attenuation						See Figure 9
Sample rate			6			Msample/s

**ELECTRICAL CHARACTERISTICS** (continued)

$T_{AMB} = -30^{\circ}\text{C}$  to  $+70^{\circ}\text{C}$ ,  $V_{CC} = +2.7$  to  $+3.6\text{V}$ . These characteristics are guaranteed by either production test or design. They apply within the specified ambient temperature and supply voltage ranges unless otherwise stated.

Characteristic	Value			Units	Conditions
	Min	Typ	Max		
<b>FM TX Interface</b>					
Resolution	8			Bits	
Integral non linearity			0.5	LSB	
Differential non linearity			0.5	LSB	
Output Voltage range		550		mVpp	
Output Voltage mid scale		0		V	Differential
PSRR		50		dB	Vdd to output, 100mV pk-pk at 100kHz
Load resistance	5			k $\Omega$	
Load capacitance			20	pF	
Filter type					Butterworth low pass
Filter order		3rd			
Filter Pass Band ripple					See Figure 9
Filter stop band attenuation					See Figure 9
Filter cut-off					See Figure 9
<b>CDMA RX Interface</b>					
Resolution	4			Bits	
Full scale input voltage		1		V pk-pk	Measured differentially
Input common mode range		Vdd -1.4		V	
Input sample rate		9.8304		Ms/s	
Input resistance (dc)	20			k $\Omega$	
Input capacitance		10	20	pF	
Integral non linearity			0.15	LSB	
Differential non linearity			0.175	LSB	
IRX and QRX gain matching			0.25	dB	

## PLUTO

### ELECTRICAL CHARACTERISTICS (CDMA BASEBAND RX INTERFACE CIRCUIT) continued

$T_{AMB} = -30^{\circ}\text{C}$  to  $+70^{\circ}\text{C}$ ,  $V_{CC} = +2.7$  to  $+3.6\text{V}$ . These characteristics are guaranteed by either production test or design. They apply within the specified ambient temperature and supply voltage ranges unless otherwise stated.

Characteristic	Value			Units	Conditions
	Min	Typ	Max		
<b>FM RX Interface</b>					
Resolution	8			Bits	Measured differentially
Full scale input voltage		1		V pk-pk	
Input dc level		$V_{dd}-1.4$		V	
Input sample rate		30	50	ks/s	
Input resistance (dc)	100			k $\Omega$	
Input capacitance		10	20	pF	
Integral non linearity			$\pm 1.5$	LSB	
Differential non linearity			$\pm 0.75$	LSB	
<b>AUXILIARY CONVERTER SECTION</b>					
Resolution	8			Bits	
ADC full scale range		2.5		V	
ADC zero scale range		0.5		V	
Integral non linearity			$\pm 1.25$	LSB	
Differential non linearity			$\pm 0.75$	LSB	
Conversion time		20		ks/s	
ADCCLK		410		kHz	

**ELECTRICAL CHARACTERISTICS** (Continued)

$T_{AMB} = -30^{\circ}\text{C}$  to  $+70^{\circ}\text{C}$ ,  $V_{CC} = +2.7$  to  $+3.6\text{V}$ . These characteristics are guaranteed by either production test or design. They apply within the specified ambient temperature and supply voltage ranges unless otherwise stated.

Characteristic	Value			Units	Conditions
	Min	Typ	Max		
<b>TRANSMIT SYNTHESISER</b>					
Input Frequency		65.19		MHz	
Lock mode output current		16		$\mu\text{A}$	Rset = 40k $\Omega$
Acquisition mode output current		176		$\mu\text{A}$	Rset = 40k $\Omega$
PD output compliance	0.5		Vdd-0.5	V	
<b>RECEIVER SYNTHESISER</b>					
Input frequency	42.69		52.595	MHz	
Lock mode output current		16		$\mu\text{A}$	Rset = 40k $\Omega$
Acquisition mode output current		176		V	Rset = 40k $\Omega$
PD output compliance	0.5		Vdd-0.5	V	
<b>POWER SUPPLY CURRENTS</b>					
Sleep			1	mA	
CDMA_IDLE		11	15	mA	
FM_ILDE		5	7	mA	
CDMA_RTXX		18	32	mA	
FM_RXTX		11	15	mA	



---

**SEMICONDUCTOR**

---

Internet: <http://www.mitelsemi.com>

---

**CUSTOMER SERVICE CENTRES**

- **FRANCE & BENELUX** Les Ulis Cedex  
Tel: (1) 69 18 90 00 Fax: (1) 64 46 06 07
- **GERMANY** Munich Tel: (089) 419508-20 Fax: (089) 419508-55
- **ITALY** Milan Tel: (02) 6607151 Fax: (02) 66040993
- **JAPAN** Tokyo Tel: (03) 5276-5501 Fax: (03) 5276-5510
- **KOREA** Seoul Tel: (2) 5668141 Fax: (2) 5697933
- **NORTH AMERICA** Scotts Valley, USA  
Tel: (408) 438 2900 Fax: (408) 438 5576/6231

- **SOUTH EAST ASIA** Singapore  
Tel:(65) 333 6193 Fax: (65) 333 6192
- **SWEDEN** Stockholm Tel: 46 8 702 97 70 Fax: 46 8 640 47 36
- **TAIWAN, ROC** Taipei Tel: 886 2 25461260 Fax: 886 2 27190260
- **UK, EIRE, DENMARK, FINLAND & NORWAY**  
Swindon Tel: (01793) 726666 Fax : (01793) 518582

These are supported by Agents and Distributors in major countries worldwide.

---

© Mitel 1998 Publication No. DS4722 Issue No. 1.8 July 1998 TECHNICAL DOCUMENTATION – NOT FOR RESALE. PRINTED IN UNITED KINGDOM

---

This publication is issued to provide information only which (unless agreed by the Company in writing) may not be used, applied or reproduced for any purpose nor form part of any order or contract nor to be regarded as a representation relating to the products or services concerned. No warranty or guarantee express or implied is made regarding the capability, performance or suitability of any product or service. The Company reserves the right to alter without prior notice the specification, design or price of any product or service. Information concerning possible methods of use is provided as a guide only and does not constitute any guarantee that such methods of use will be satisfactory in a specific piece of equipment. It is the user's responsibility to fully determine the performance and suitability of any equipment using such information and to ensure that any publication or data used is up to date and has not been superseded. These products are not suitable for use in any medical products whose failure to perform may result in significant injury or death to the user. All products and materials are sold and services provided subject to the Company's conditions of sale, which are available on request.

All brand names and product names used in this publication are trademarks, registered trademarks or trade names of their respective owners.